

ABCS GRP Control Stations

Based on Abtech's rugged anti-static carbon loaded GRP BPG range, the ABCS offers high levels of impact resistance and protection against the ingress of dust and water.

A wide range of push buttons, switches, indicator lamps, emergency stop devices and voltmeters or ammeters are available.

Optional terminals can also be fitted, allowing pre-wiring of components and simplified installation.



IP66



Product Specification

Apparatus Type	Control Stations
Ingress Protection	IP66 to EN60529
Enclosure Material	Carbon loaded glass reinforced polyester (GREY non-carbon loaded optional)
Mounting Plate	Pertinax (optional)
Components	Standard parts list attached. Refer to certificates for further options and details.
Voltage Rating	Up to 400V (varies according to parts fitted)
Cable Entry	Metric or clearance hole entry combinations on any of the 4 sides
Mounting	Via rear mounting holes
Certification	
Area Classification	Zone 1 & 21, Gas and Dust
Types of Protection	Flameproof, increased safety, encapsulation, dust
Apparatus Coding	Ex db eb mb T* Gb, Ex tb* IIIC T* °C Db (varies according to combination of parts fitted)
Ambient Temperature	Standard max. range -40°C ≤ Tamb ≤ 60°C (options available for -55°C)
Certificate Numbers	CML 16ATEX3149X, IECEx CML16.0066X

Configuration options (see typical layout drawings overleaf)

Part Number	Dimensions WxHxD (mm)	Maximum Populations Guidance*			
		Operators Only	W/ Terminals	W/ Ammeter	W/ Ammeter & Terminals
ABCS6	122x120x90	1 x Op	N/A	N/A	N/A
ABCS7	120x220x90	3 x Op	2 x Op	1 x Op, 1 x Am	1 x Am
ABCS8	160x160x90	4 x Op	2 x Op	1 x Am	N/A
ABCS9	160x260x90	6 x Op	6 x Op	4 x Op, 1 x Am	2 x Op, 1 x Am
ABCS10	160x360x90	10 x Op	8 x Op	4 x Op, 2 x Am	2 x Op, 2 x Am
ABCS11	160x560x90	16 x Op	14 x Op	8 x Op, 3 x Am	6 x Op, 3 x Am
ABCS12	255x250x120	9 x Op	6 x Op	6 x Op, 2 x Am	3 x Op, 2 x Am
ABCS13	250x400x120	18 x Op	15 x Op	9 x Op, 4 x Am	6 x Op, 2 x Am
ABCS14	250x600x120	26 x Op	23 x Op	12 x Op, 6 x Am	9 x Op, 6 x Am
ABCS15	400x405x120	30 x Op	25 x Op	15 x Op, 6 x Am	10 x Op, 6 x Am

* Based on 2 pole operators. 4 pole options are available, please contact sales for more information.
Also available in non-carbon loaded GRP (Grey) – Add suffix GREY

Example Layout Drawings

OPERATORS ONLY	W/ TERMINALS	W/ AMMETER	W/ AMMETER & TERMINALS
 <p>ABCS6/1-0</p>			
 <p>ABCS7/3-0</p>	 <p>ABCS7/2-0/T</p>	 <p>ABCS7/1-1</p>	 <p>ABCS7/0-1/T</p>
 <p>ABCS8/4-0</p>	 <p>ABCS8/2-0/T</p>	 <p>ABCS8/0-1</p>	
 <p>ABCS9/6-0</p>	 <p>ABCS9/6-0/T</p>	 <p>ABCS9/4-1</p>	 <p>ABCS9/2-1/T</p>
 <p>ABCS10/10-0</p>	 <p>ABCS10/8-0/T</p>	 <p>ABCS10/4-2</p>	 <p>ABCS10/2-2/T</p>

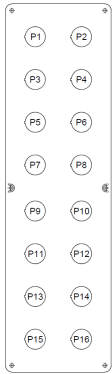
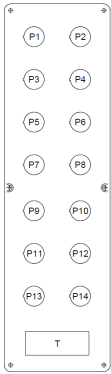
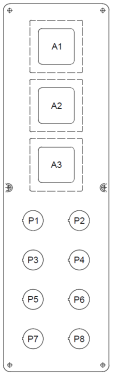
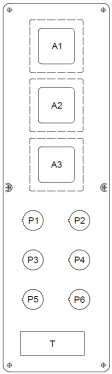
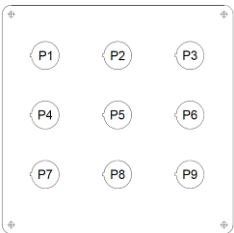
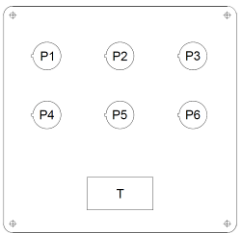
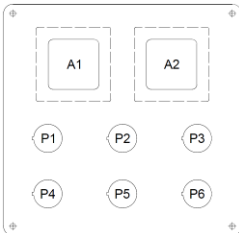
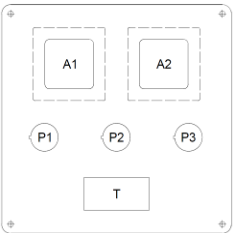
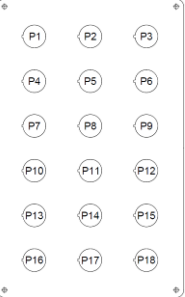
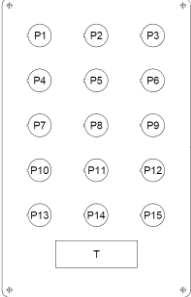
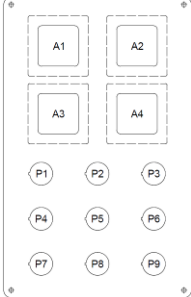
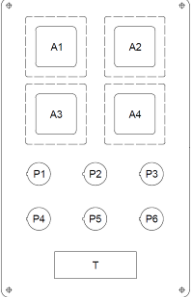
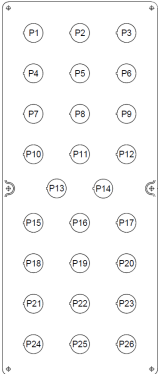
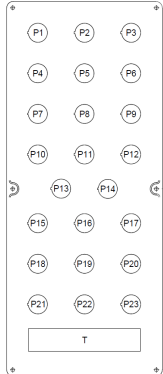
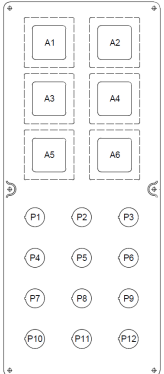
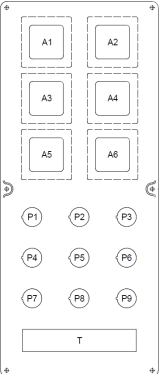
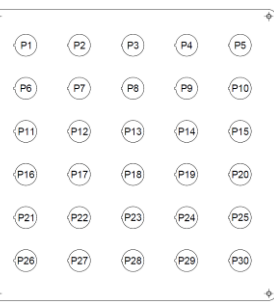
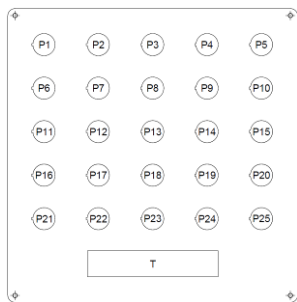
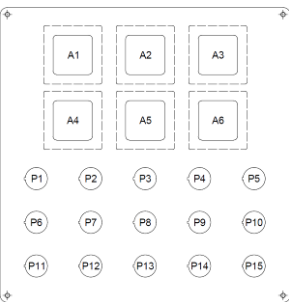
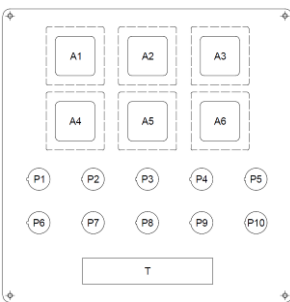
 <p>ABCS11/16-0</p>	<p>ABT31082</p>  <p>ABCS11/14-0/T</p>	<p>ABT31082</p>  <p>ABCS11/8-3</p>	<p>ABT31083</p>  <p>ABCS11/6-3/T</p>
 <p>ABCS12/9-0</p>	<p>ABT31084</p>  <p>ABCS12/6-0/T</p>	<p>ABT31084</p>  <p>ABCS12/6-2</p>	<p>ABT31085</p>  <p>ABCS12/3-2/T</p>
 <p>ABCS13/18-0</p>	<p>ABT31086</p>  <p>ABCS13/16-0/T</p>	<p>ABT31086</p>  <p>ABCS13/9-4</p>	<p>ABT31087</p>  <p>ABCS13/6-4/T</p>
 <p>ABCS14/26-0</p>	<p>ABT31088</p>  <p>ABCS14/23-0/T</p>	<p>ABT31088</p>  <p>ABCS14/12-6</p>	<p>ABT31089</p>  <p>ABCS14/9-6/T</p>
 <p>ABCS15/30-0</p>	<p>ABT31090</p>  <p>ABCS15/25-0/T</p>	<p>ABT31090</p>  <p>ABCS15/15-6</p>	<p>ABT31091</p>  <p>ABCS15/10-6/T</p>





Operators & Contacts

Technical Data for all non-illuminated button and switch contact blocks

Certification	Ex db eb IIC Gb				
Ambient Temperature Range	Standard: -40°C to +60°C Optional: -55°C to +60°C				
Connections	2.5mm ² terminals				
Utilization Category (as per BS EN 60947-1)	AC-12	AC-15	AC-3	AC-23	DC-13
Rated Voltage	400V			110V	
Rated Current	16A			1A	

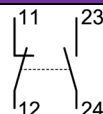

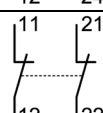
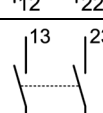
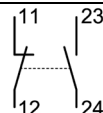
Momentary Push Buttons

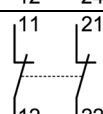
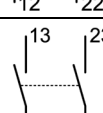
Part Code	Part Description	Contact Configuration	Typical Part Image
COP170xx	P1 Push button, 1NC/1NO contacts	 1NC/1NO	
COP171xx	P1 Push button, 2NC contacts	 2NC	
COP172xx	P1 Push button, 2NO contacts	 2NO	
COP270xx/xx	P2 Double Push button, 1NC/1NO contacts	 1NC/1NO	
COP271xx/xx	P2 Double Push button, 2NC contacts	 2NC	
COP272xx/xx	P2 Double Push button, 2NO contacts	 2NO	





Label disc kit supplied with each push button.





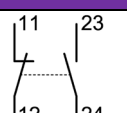

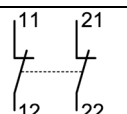
(Other label options are available on request)



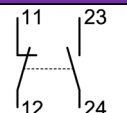

CODE	LEGEND	LABEL COLOUR	TEXT COLOUR
01	"BLANK"	Green	N/A
02	I	Green	White
03	ON	Green	White
04	START	Green	White
21	"BLANK"	Red	N/A
22	O	Red	White
23	OFF	Red	White
24	STOP	Red	White
41	"BLANK"	White	N/A
81	"BLANK"	Black	N/A

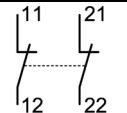
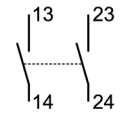
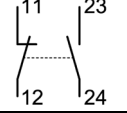
Momentary Mushroom Buttons

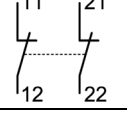
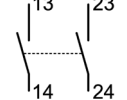

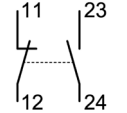

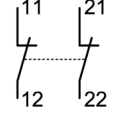

Part Code	Part Description	Contact Configuration	Typical Part Image
COP4G70	Momentary mushroom head button (P4G Green), 1NC/1NO contacts	 1NC/1NO	
COP4G71	Momentary mushroom head button (P4G Green), 2NC contacts	 2NC	
COP4G72	Momentary mushroom head button (P4G Green), 2NO contacts	 2NO	
OPTION: Also available in Black (P4B) or Red (P4R)			

Emergency Stop Buttons

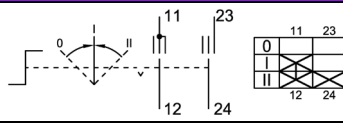

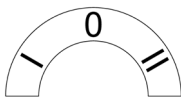
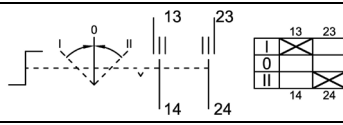
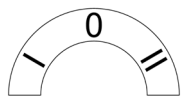
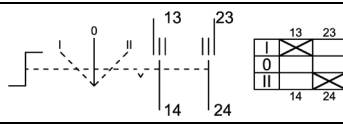
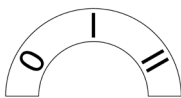
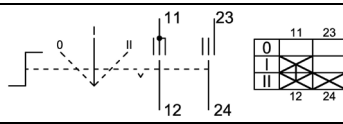

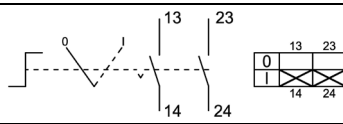

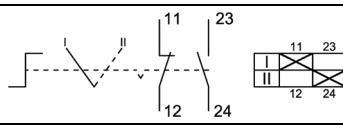
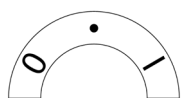
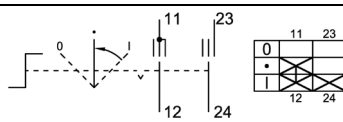

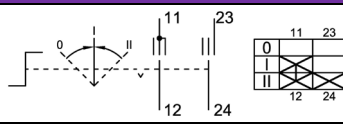

Part Code	Part Description	Contact Configuration	Typical Part Image
COP370	P3 E-stop mushroom head, pull to release, 1NC/1NO contacts	 1NC/1NO	
COP371	P3 E-stop mushroom head, pull to release, 2NC contacts	 2NC	
COP372	P3 E-stop mushroom head, pull to release, 2NO contacts	 2NO	
COP670	P6 E-stop mushroom head, twist to release, 1NC/1NO contacts	 1NC/1NO	
COP671	P6 E-stop mushroom head, twist to release, 2NC contacts	 2NC	
COP672	P6 E-stop mushroom head, twist to release, 2NO contacts	 2NO	

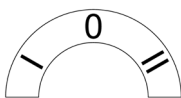
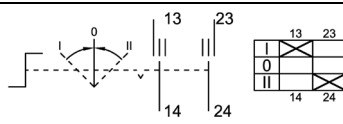
Part Code	Part Description	Contact Configuration	Typical Part Image
COY2170	Y21 E-stop mushroom head, key release, 1NC/1NO contacts	 1NC/1NO	
COY2171	Y21 E-stop mushroom head, key release, 2NC contacts	 2NC	
COY2172	Y21 E-stop mushroom head, key release, 2NO contacts	 2NO	

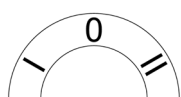

Small Handle Selector Switches (ø39mm)

Part Code	Part Description	Label	Contact Schematic	Typical Part Image
COK47003	K4 3-position small handle, self-reset, "0-I-II"			
COK47204	K4 3-position small handle, self-reset, "I-0-II"			
COK57204	K5 3-position small handle, self-lock, "I-0-II"			
COK57003	K5 3-position small handle, self-lock, "0-I-II"			
COK67201	K6 2-position small handle, self-lock, "0-I"			
COK67002	K6 2-position small handle, self-lock, "I-II"			
COK87005	K8 3-position small handle, self-lock/reset, "0-•-I"			

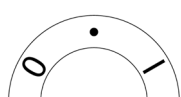
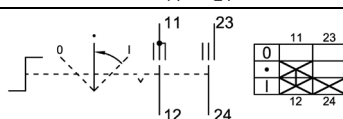
Large Handle Selector Switches (ø62mm)

Part Code	Part Description	Label	Contact Schematic	Typical Part Image
COS47003	S4 3-position large handle, self-reset, "0-I-II"			
COS47204	S4 3-position large handle, self-reset, "I-0-II"			
COS57003	S5 3-position large handle, self-lock, "0-I-II"			
COS57204	S5 3-position large handle, self-lock, "I-0-II"			
COS67002	S6 2-position large handle, self-lock, "I-II"			
COS67201	S6 2-position large handle, self-lock, "0-I"			
COS87005	S8 3-position large handle, self-lock/reset, "0-•-I"			

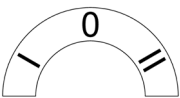
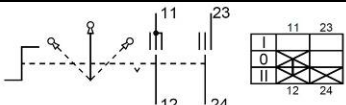

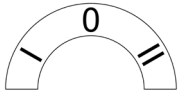
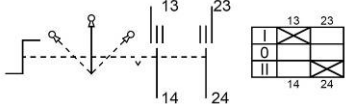
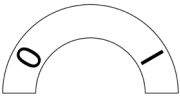
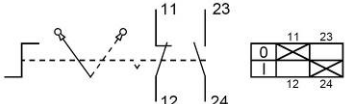
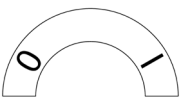
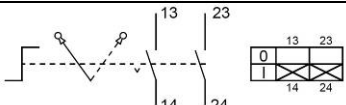
Key Switches

Part Code	Part Description	Label	Contact Schematic	Typical Part Image
COY5170	Y51 3-position key switch, self-lock, "I-O-II"			
COY5172	Y51 3-position key switch, self-lock, "I-O-II"			
COY6170	Y61 2-position key switch, self-lock, "0-I"			
Y6172	Y61 2-position key switch, self-lock, "0-I"			

Potentiometers

Technical data for potentiometer modules

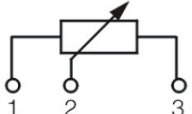
Certification	Ex db eb IIC Gb	
Ambient Temperature Range	Standard: -40°C to +60°C Optional: -55°C to +60°C	
Connections	2.5mm ² terminals	
Rated Voltage	Max. 200V DC	

Part Code	Part Description	Contact Schematic	Typical Part Image
CODW1701	DW1 100Ω Potentiometer		
CODW1702	DW1 200Ω Potentiometer		
CODW1703	DW1 500Ω Potentiometer		
CODW1704	DW1 1kΩ Potentiometer		
CODW1705	DW1 2kΩ Potentiometer		
CODW1706	DW1 5kΩ Potentiometer		
CODW1707	DW1 10kΩ Potentiometer		
CODW1708	DW1 20kΩ Potentiometer		
CODW1709	DW1 50kΩ Potentiometer		
CODW1710	DW1 100kΩ Potentiometer		
CODW1711	DW1 200kΩ Potentiometer		
CODW1712	DW1 500kΩ Potentiometer		
CODW1713	DW1 1MΩ Potentiometer		
CODW1714	DW1 2MΩ Potentiometer		

Indicator Lamps

Technical data for lamp power modules		
Certification	Ex db eb IIC Gb	
Ambient Temperature Range	Standard: -40°C to +60°C Optional: -55°C to +60°C	
Connections	2.5mm ² terminals	
Standard Rated Voltage	20-250V AC/DC	
Alternative Voltage Options	10-28V AC/DC, 50-277V AC/DC or 380-400V AC Available on request	





Part Code	Part Description	Voltage Range	Typical Part Image
CLLR7R1	Indicator lamp, Red	20 - 250V AC/DC	
CLLG7G1	Indicator lamp, Green		
CLLY7Y1	Indicator lamp, Yellow		
CLLB7B1	Indicator lamp, Blue		
CLLW7W1	Indicator lamp, White		

Illuminated Push Buttons

Technical data for illuminated push button modules		
Certification	Ex db eb IIC Gb	
Ambient Temperature Range	Standard: -40°C to +60°C Optional: -55°C to +60°C	
Connections	2.5mm ² terminals	
Button Utilization category (as per BS EN 60947-1)	AC-15	DC-13
Button Rated Voltage	250V	24V
Button Rated Current	10A	1A
Lamp Standard Rated Voltage	20-250V AC/DC	
Alternative Voltage Options	10-28V AC/DC or 50-277V AC/DC Available on request	

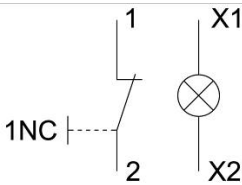

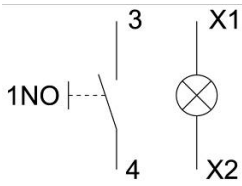
Part Code	Part Description	Contact Configuration/Voltage Range	Typical Part Image
COPR73R1	Illuminated Push Button, Red (1NC)	 <p>20 - 250V AC/DC</p>	
COPG73G1	Illuminated Push Button, Green (1NC)		
COPY73Y1	Illuminated Push Button, Yellow (1NC)		
COPB73B1	Illuminated Push Button, Blue (1NC)		
COPW73W1	Illuminated Push Button, White (1NC)		
COPR74R1	Illuminated Push Button, Red (1NO)	 <p>20 - 250V AC/DC</p>	
COPG74G1	Illuminated Push Button, Green (1NO)		
COPY74Y1	Illuminated Push Button, Yellow (1NO)		
COPB74B1	Illuminated Push Button, Blue (1NO)		
COPW74W1	Illuminated Push Button, White (1NO)		

OPTION: 10-28V Ex ia intrinsically safe lamp and illuminated push button options available on request.

Ammeters

Technical data for ammeters	
Certification	Ex eb IIC Gb
Ambient Temperature Range	-40°C to +60°C
Connections	2.5mm ² terminals

Part Code	Measuring Method	Measuring Range	Overload Scale	Typical Part Image
CAM7WAxx/1-2	1A CT	See scales below	x2	
CAM7WAxx/1-5	1A CT	See scales below	x5	
CAM7WAxx/5-2	5A CT	See scales below	x2	
CAM7WAxx/5-5	5A CT	See scales below	x5	
Ammeter Scale Options				
CACZ0205-0-1A/□-□	1A or 5A CT (Current Transformer)	0--1A	2A or 5A	
CACZ0205-0-2.5A/□-□		0--2.5A	5A or 12.5A	
CACZ0205-0-5A/□-□		0--5A	10A or 25A	
CACZ0205-0-15A/□-□		0--15A	30A or 75A	
CACZ0205-0-25A/□-□		0--25A	50A or 125A	
CACZ0205-0-40A/□-□		0--40A	80A or 200A	
CACZ0205-0-50A/□-□		0--50A	100A or 250A	
CACZ0205-0-60A/□-□		0--60A	120A or 300A	
CACZ0205-0-75A/□-□		0--75A	150A or 375A	
CACZ0205-0-100A/□-□		0--100A	200A or 500A	
CACZ0205-0-150A/□-□		0--150A	300A or 750A	
CACZ0205-0-200A/□-□		0--200A	400A or 1000A	
CACZ0205-0-250A/□-□		0--250A	500A or 1250A	
CACZ0205-0-300A/□-□		0--300A	600A or 1500A	
CACZ0205-0-400A/□-□		0--400A	800A or 2000A	
CACZ0205-0-500A/□-□		0--500A	1000A or 2500A	
CACZ0205-0-600A/□-□		0--600A	1200A or 3000A	

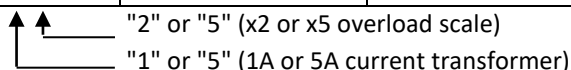

(Direct measuring and milammeter options also available on request)

Voltmeters

Technical data for Voltmeters & Milammeters	
Certification	Ex eb mb IIC Gb
Ambient Temperature Range	-40°C to +60°C
Connections	2.5mm ² terminals

Part Code	Measuring Range	Typical Part Image
CVM7V25- EXM	0-25V AC	
CVM7V40-EXM	0-40V AC	
CVM7V150-EXM	0-150V AC	
CVM7V250-EXM	0-250V AC	
CVM7V500-EXM	0-500V AC	

Accessories

Part Code	Description	Typical Part Image
COCZ40191-7	Clear Cover for P3 , P4 and P6 mushroom buttons	
COCZ40192-7	Padlockable guard for P3 and P6 mushroom buttons (Note: Padlock not included)	
COCZ40193-7	Locking cover for P1 button or K switch (Note: Padlock not included)	
COCZ40194-7	Constant Pressure Lock Cover for P1 button (Note: Padlock not included)	
COCZ4019-5	Safety latch for P2 double button	
COCZ4031-1	Label holder surround for P , K , Y and DW1 type operators (Suits label size 35.5x18mm)	
COCZB1	B1 Blanking Plug for unused operator holes	